

## Power SMD LED PLCC-2

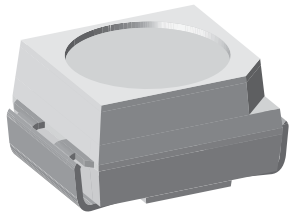

19225

### DESCRIPTION

The VLM.33.. series is an advanced modification of the Vishay VLM.33.. series. It is designed to incorporate larger chips, therefore, capable of withstanding a 50 mA drive current.

The package of the VLM.33.. is the PLCC-2.

It consists of a lead frame which is embedded in a white thermoplast. The reflector inside this package is filled up with clear epoxy.

### PRODUCT GROUP AND PACKAGE DATA

- Product group: LED
- Product series: SMD Power
- Package: PLCC-2
- Angle of half intensity:  $\pm 60^\circ$

### FEATURES

- Utilizing (AS) AlInGaP technology
- Available in 8 mm tape
- Luminous intensity and color categorized per packing unit
- Luminous intensity ratio per packing unit  $I_{Vmax}/I_{Vmin} \leq 1.6$
- Thermal resistance  $R = 400 \text{ K/W}$
- ESD-withstand voltage: up to 2 kV according to JESD22-A114-B
- Preconditioning: acc. to JEDEC level 2a
- Compatible with reflow, vapor phase and wave solder processes according to CECC 00802 and J-STD-020
- Compliant to RoHS Directive 2002/95/EC and in accordance to WEEE 2002/96/EC
- AEC-Q101 qualified

 AUTOMOTIVE  
GRADE

 RoHS  
COMPLIANT

 GREEN  
(5-2008)\*\*

### APPLICATIONS

- Traffic signals and signs
- Interior and exterior lighting
- Dashboard illumination
- Indicator and backlighting purposes for audio, video, LCDs switches, symbols, illuminated advertising etc.

### PARTS TABLE

PART	COLOR, LUMINOUS INTENSITY	TECHNOLOGY
VLMR33T1U2-GS08	Amber, $I_V = (280 \text{ to } 710) \text{ mcd}$	AllnGaP on GaAs
VLMR33T1U2-GS18	Amber, $I_V = (280 \text{ to } 710) \text{ mcd}$	AllnGaP on GaAs
VLMR33R2U2-GS08	Amber, $I_V = (140 \text{ to } 710) \text{ mcd}$	AllnGaP on GaAs
VLMR33R2U2-GS18	Amber, $I_V = (140 \text{ to } 710) \text{ mcd}$	AllnGaP on GaAs
VLMS33S1T2-GS08	Super red, $I_V = (180 \text{ to } 450) \text{ mcd}$	AllnGaP on GaAs
VLMS33S1T2-GS18	Super red, $I_V = (180 \text{ to } 450) \text{ mcd}$	AllnGaP on GaAs
VLMS33S1U1-GS08	Super red, $I_V = (180 \text{ to } 560) \text{ mcd}$	AllnGaP on GaAs
VLMS33S1U1-GS18	Super red, $I_V = (180 \text{ to } 560) \text{ mcd}$	AllnGaP on GaAs
VLMO33S1T2-GS08	Soft orange, $I_V = (180 \text{ to } 450) \text{ mcd}$	AllnGaP on GaAs
VLMO33S1T2-GS18	Soft orange, $I_V = (180 \text{ to } 450) \text{ mcd}$	AllnGaP on GaAs
VLMO33T1U2-GS08	Soft orange, $I_V = (280 \text{ to } 710) \text{ mcd}$	AllnGaP on GaAs
VLMO33T1U2-GS18	Soft orange, $I_V = (280 \text{ to } 710) \text{ mcd}$	AllnGaP on GaAs

\*\* Please see document "Vishay Material Category Policy": [www.vishay.com/doc?99902](http://www.vishay.com/doc?99902)

PARTS TABLE		
PART	COLOR, LUMINOUS INTENSITY	TECHNOLOGY
VLMO33R2U2-GS08	Soft orange, $I_V = (140 \text{ to } 710) \text{ mcd}$	AllnGaP on GaAs
VLMO33R2U2-GS18	Soft orange, $I_V = (140 \text{ to } 710) \text{ mcd}$	AllnGaP on GaAs
VLMY33T1U2-GS08	Yellow, $I_V = (280 \text{ to } 710) \text{ mcd}$	AllnGaP on GaAs
VLMY33T1U2-GS18	Yellow, $I_V = (280 \text{ to } 710) \text{ mcd}$	AllnGaP on GaAs
VLMY33R2U2-GS08	Yellow, $I_V = (140 \text{ to } 710) \text{ mcd}$	AllnGaP on GaAs
VLMY33R2U2-GS18	Yellow, $I_V = (140 \text{ to } 710) \text{ mcd}$	AllnGaP on GaAs

ABSOLUTE MAXIMUM RATINGS ( $T_{\text{amb}} = 25 \text{ }^\circ\text{C}$ , unless otherwise specified) VLM.33..				
PARAMETER	TEST CONDITION	SYMBOL	VALUE	UNIT
Reverse voltage <sup>1)</sup>		$V_R$	5	V
DC forward current	$T_{\text{amb}} \leq 73 \text{ }^\circ\text{C}$ (400 K/W)	$I_F$	50	mA
Power dissipation		$P_V$	130	mW
Junction temperature		$T_j$	125	$^\circ\text{C}$
Operating temperature range		$T_{\text{amb}}$	- 40 to + 100	$^\circ\text{C}$
Storage temperature range		$T_{\text{stg}}$	- 40 to + 100	$^\circ\text{C}$
Thermal resistance junction/ambient	Mounted on PC board (pad size > 16 mm <sup>2</sup> )	$R_{\text{thJA}}$	400	K/W

Note:

<sup>1)</sup> Driving the LED in reverse direction is suitable for a short term application

OPTICAL AND ELECTRICAL CHARACTERISTICS ( $T_{\text{amb}} = 25 \text{ }^\circ\text{C}$ , unless otherwise specified) VLMR33.., AMBER							
PARAMETER	TEST CONDITION	PART	SYMBOL	MIN	TYP.	MAX	UNIT
Luminous intensity	$I_F = 30 \text{ mA}$	VLMR33T1U2	$I_V$	280		710	mcd
		VLMR33R2U2	$I_V$	140		710	mcd
Luminous flux/Luminous intensity			$\phi_V/I_V$		3		mlm/mcd
Dominant wavelength	$I_F = 30 \text{ mA}$		$\lambda_d$	611	617	622	nm
Peak wavelength	$I_F = 30 \text{ mA}$		$\lambda_p$		624		nm
Spectral bandwidth at 50 % $I_{\text{rel max}}$	$I_F = 30 \text{ mA}$		$\Delta\lambda$		18		nm
Angle of half intensity	$I_F = 30 \text{ mA}$		$\varphi$		$\pm 60$		deg
Forward voltage	$I_F = 30 \text{ mA}$		$V_F$	1.7	2	2.5	V
Reverse current	$V_R = 5 \text{ V}$		$I_R$		0.01	10	$\mu\text{A}$

<b>OPTICAL AND ELECTRICAL CHARACTERISTICS</b> ( $T_{amb} = 25\text{ }^{\circ}\text{C}$ , unless otherwise specified) <b>VLMS33.., SUPER RED</b>							
PARAMETER	TEST CONDITION	PART	SYMBOL	MIN.	TYP.	MAX.	UNIT
Luminous intensity	$I_F = 30\text{ mA}$	VLMS33S1T2	$I_V$	180		450	mcd
		VLMS33S1U1	$I_V$	180		560	mcd
Luminous flux/Luminous intensity			$\phi_V/I_V$		3		mlm/mcd
Dominant wavelength	$I_F = 30\text{ mA}$		$\lambda_d$	626	630	638	nm
Peak wavelength	$I_F = 30\text{ mA}$		$\lambda_p$		641		nm
Spectral bandwidth at 50 % $I_{rel\ max}$	$I_F = 30\text{ mA}$		$\Delta\lambda$		17		nm
Angle of half intensity	$I_F = 30\text{ mA}$		$\varphi$		$\pm 60$		deg
Forward voltage	$I_F = 30\text{ mA}$		$V_F$	1.7	2	2.5	V
Reverse current	$V_R = 5\text{ V}$		$I_R$		0.01	10	$\mu\text{A}$

<b>OPTICAL AND ELECTRICAL CHARACTERISTICS</b> ( $T_{amb} = 25\text{ }^{\circ}\text{C}$ , unless otherwise specified) <b>VLMO33.., SOFT ORANGE</b>							
PARAMETER	TEST CONDITION	PART	SYMBOL	MIN.	TYP.	MAX.	UNIT
Luminous intensity	$I_F = 30\text{ mA}$	VLMO33S1T2	$I_V$	180		450	mcd
		VLMO33T1U2	$I_V$	280		710	mcd
		VLMO33R2U2	$I_V$	140		710	mcd
Luminous flux/Luminous intensity			$\phi_V/I_V$		3		mlm/mcd
Dominant wavelength	$I_F = 30\text{ mA}$		$\lambda_d$	600	605	611	nm
Peak wavelength	$I_F = 30\text{ mA}$		$\lambda_p$		611		nm
Spectral bandwidth at 50 % $I_{rel\ max}$	$I_F = 30\text{ mA}$		$\Delta\lambda$		17		nm
Angle of half intensity	$I_F = 30\text{ mA}$		$\varphi$		$\pm 60$		deg
Forward voltage	$I_F = 30\text{ mA}$		$V_F$	1.7	2	2.5	V
Reverse current	$V_R = 5\text{ V}$		$I_R$		0.01	10	$\mu\text{A}$

<b>OPTICAL AND ELECTRICAL CHARACTERISTICS</b> ( $T_{amb} = 25\text{ }^{\circ}\text{C}$ , unless otherwise specified) <b>VLMY33.., YELLOW</b>							
PARAMETER	TEST CONDITION	PART	SYMBOL	MIN.	TYP.	MAX.	UNIT
Luminous intensity	$I_F = 30\text{ mA}$	VLMY33T1U2	$I_V$	280		710	mcd
		VLMY33R2U2	$I_V$	140		710	mcd
Luminous flux/Luminous intensity			$\phi_V/I_V$		3		mlm/mcd
Dominant wavelength	$I_F = 30\text{ mA}$		$\lambda_d$	583	588	594	nm
Peak wavelength	$I_F = 30\text{ mA}$		$\lambda_p$		590		nm
Spectral bandwidth at 50 % $I_{rel\ max}$	$I_F = 30\text{ mA}$		$\Delta\lambda$		18		nm
Angle of half intensity	$I_F = 30\text{ mA}$		$\varphi$		$\pm 60$		deg
Forward voltage	$I_F = 30\text{ mA}$		$V_F$	1.7	2	2.5	V
Reverse current	$V_R = 5\text{ V}$		$I_R$		0.01	10	$\mu\text{A}$

COLOR CLASSIFICATION						
GROUP	DOMINANT WAVELENGTH (nm)					
	AMBER		SOFT ORANGE		YELLOW	
	MIN.	MAX.	MIN.	MAX.	MIN.	MAX.
1	611	618	598	601	581	584
2	614	622	600	603	583	586
3			602	605	585	588
4			604	607	587	590
5			606	609	589	592
6			608	611	591	594

Note:  
Wavelengths are tested at a current pulse duration of 25 ms.

LUMINOUS INTENSITY CLASSIFICATION			
GROUP	LUMINOUS INTENSITY (mcd)		
	STANDARD	OPTIONAL	MIN.
P	1	45	56
	2	56	71
Q	1	71	90
	2	90	112
R	1	112	140
	2	140	180
S	1	180	224
	2	224	280
T	1	280	355
	2	355	450
U	1	450	560
	2	560	710

Note:  
Luminous intensity is tested at a current pulse duration of 25 ms and an accuracy of  $\pm 11\%$ .

The above type Numbers represent the order groups which include only a few brightness groups. Only one group will be shipped on each reel (there will be no mixing of two groups on each reel).

In order to ensure availability, single brightness groups will not be orderable.

In a similar manner for colors where wavelength groups are measured and binned, single wavelength groups will be shipped on any one reel.

In order to ensure availability, single wavelength groups will not be orderable.

CROSSING TABLE	
VISHAY	OSRAM
VLMS33S1T2	LST67B-S1T2
VLMS33S1U1	LST67B-T1U1

**TYPICAL CHARACTERISTICS** ( $T_{amb} = 25\text{ }^{\circ}\text{C}$ , unless otherwise specified)

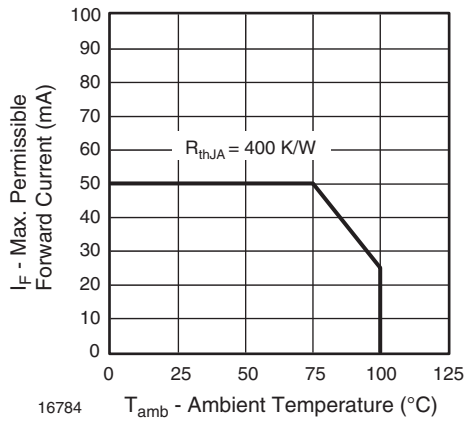

Figure 1. Forward Current vs. Ambient Temperature

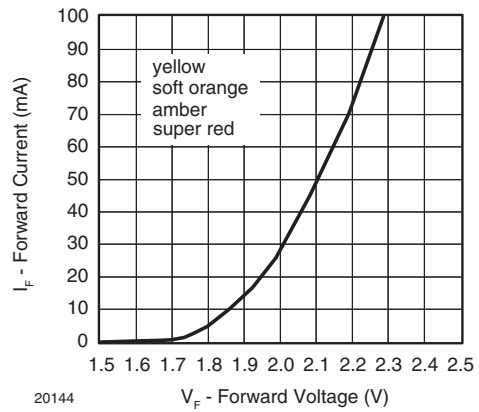

Figure 4. Forward Current vs. Forward Voltage

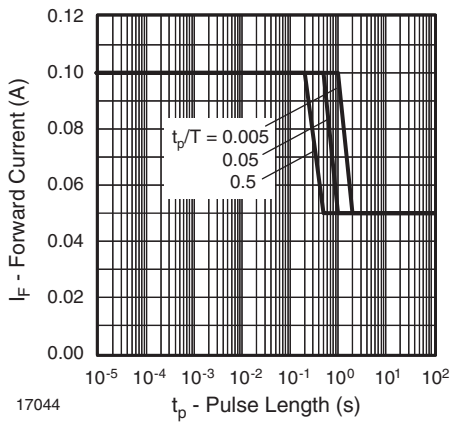

Figure 2. Forward Current vs. Pulse Length

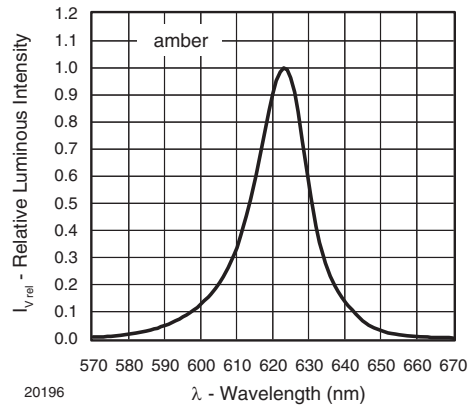

Figure 5. Relative Intensity vs. Wavelength

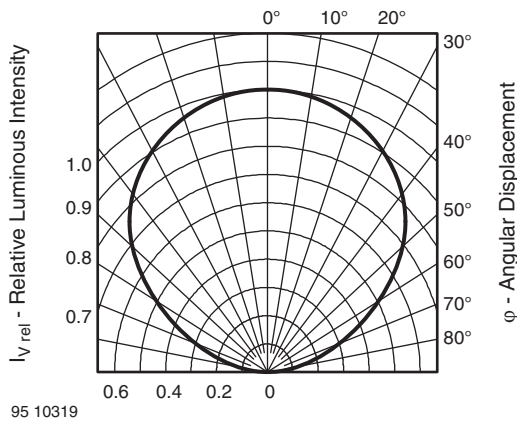

Figure 3. Rel. Luminous Intensity vs. Angular Displacement

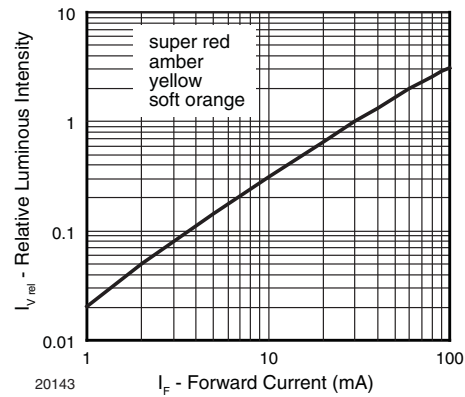

Figure 6. Relative Luminous Intensity vs. Forward Current

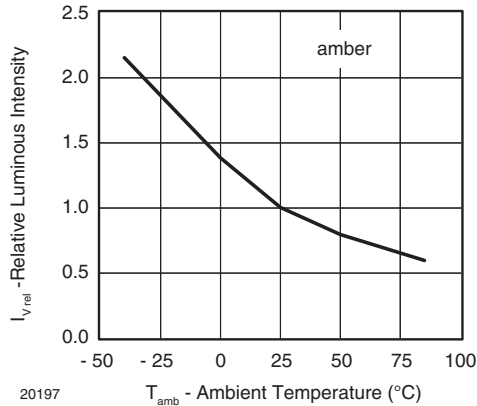

Figure 7. Relative Luminous Intensity vs. Amb. Temperature

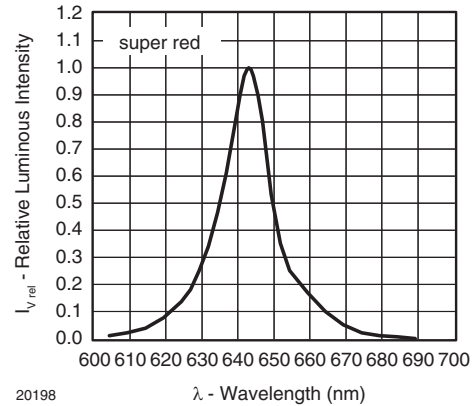

Figure 10. Relative Intensity vs. Wavelength

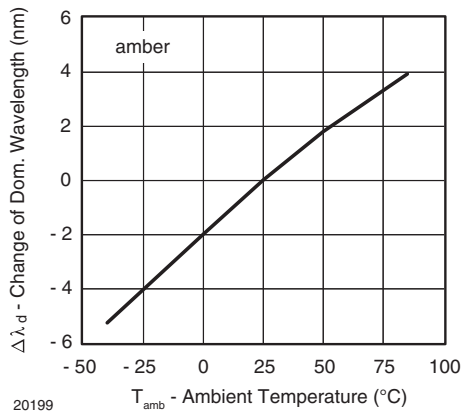

Figure 8. Change of Dominant Wavelength vs. Ambient Temperature

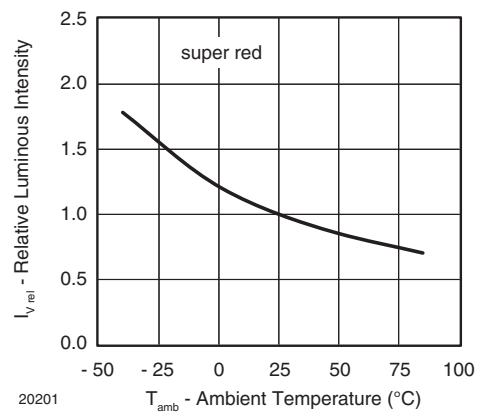

Figure 11. Relative Luminous Intensity vs. Amb. Temperature

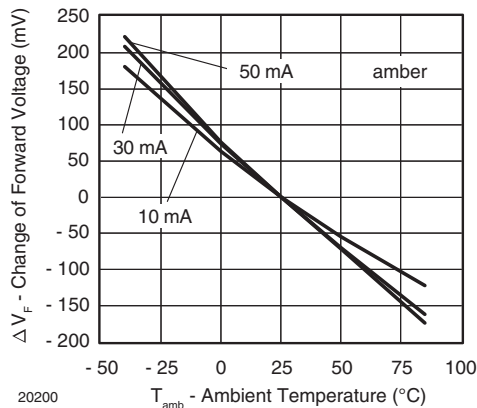

Figure 9. Change of Forward Voltage vs. Ambient Temperature

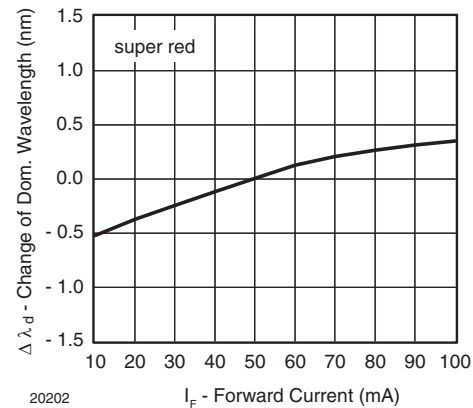

Figure 12. Change of Dominant Wavelength vs. Forward Current

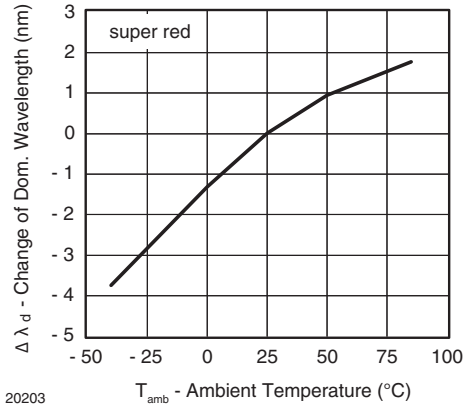

Figure 13. Change of Dominant Wavelength vs. Ambient Temperature

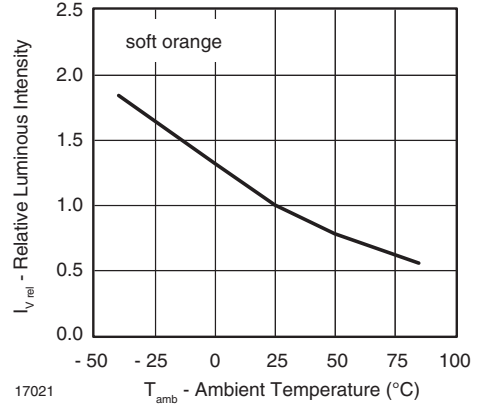

Figure 16. Relative Luminous Intensity vs. Amb. Temperature

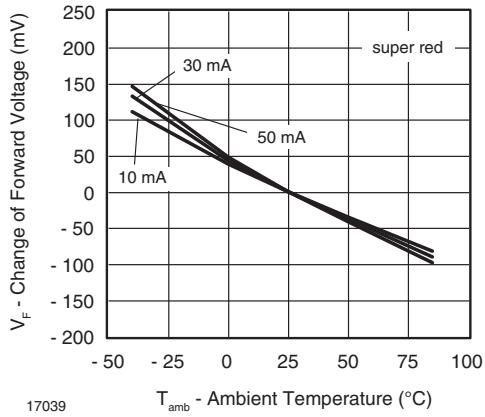

Figure 14. Change of Forward Voltage vs. Ambient Temperature

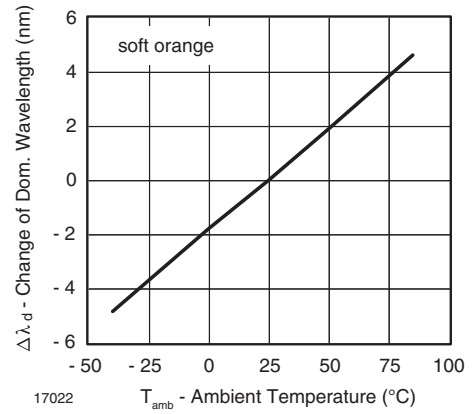

Figure 17. Change of Dominant Wavelength vs. Ambient Temperature

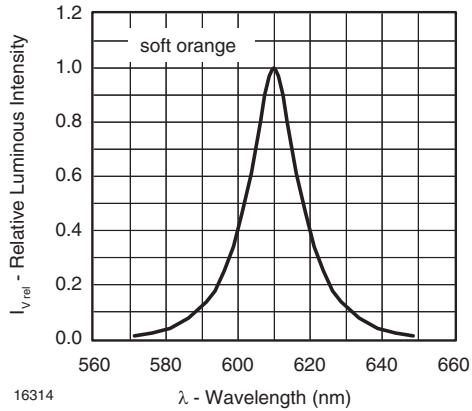

Figure 15. Relative Intensity vs. Wavelength

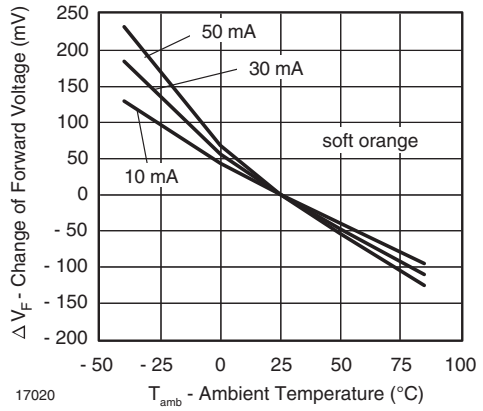

Figure 18. Change of Forward Voltage vs. Ambient Temperature

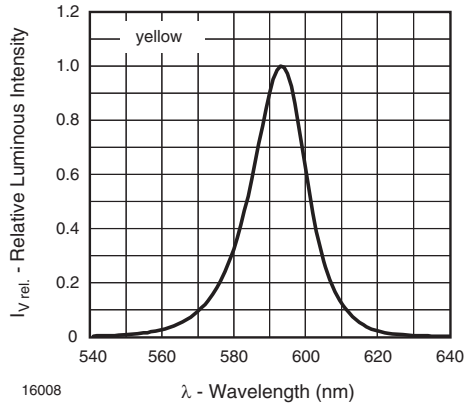

Figure 19. Relative Intensity vs. Wavelength

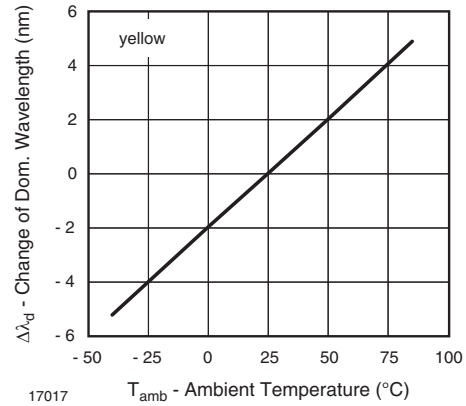

Figure 21. Change of Dominant Wavelength vs. Ambient Temperature

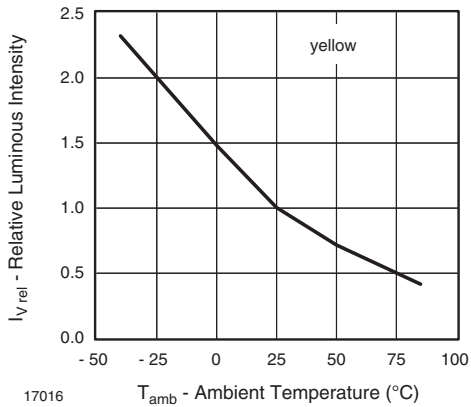

Figure 20. Relative Luminous Intensity vs. Amb. Temperature

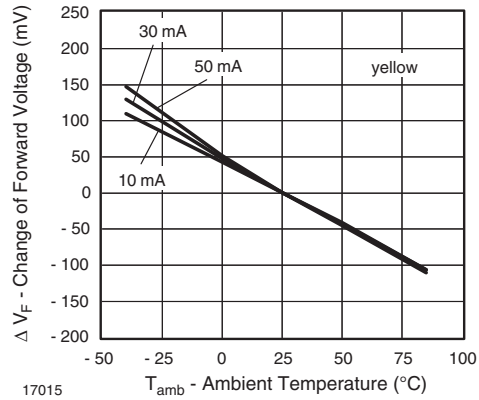
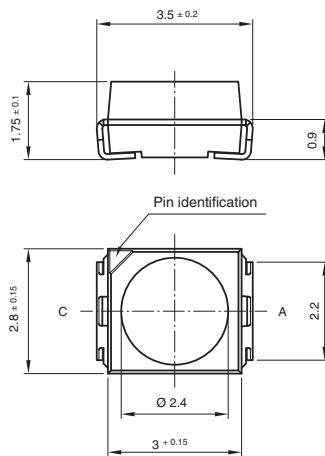
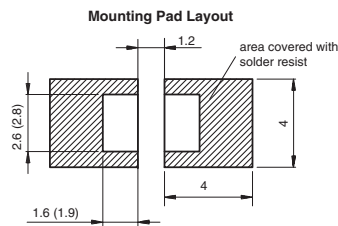

Figure 22. Change of Forward Voltage vs. Ambient Temperature

**PACKAGE DIMENSIONS** in millimeters



technical drawings according to DIN specifications



Drawing-No.: 6.541-5067.01-4  
Issue: 5; 04.11.08  
20541



**METHOD OF TAPING/POLARITY AND TAPE AND REEL**

**SMD LED (VLM3 - SERIES)**

Vishay's LEDs in SMD packages are available in an antistatic 8 mm blister tape (in accordance with DIN IEC 40 (CO) 564) for automatic component insertion. The blister tape is a plastic strip with impressed component cavities, covered by a top tape.

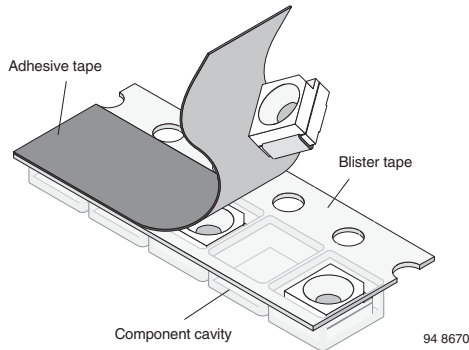

**REEL PACKAGE DIMENSION IN MILLIMETERS FOR SMD LEDS, TAPE OPTION GS08 (= 1500 PCS.)**

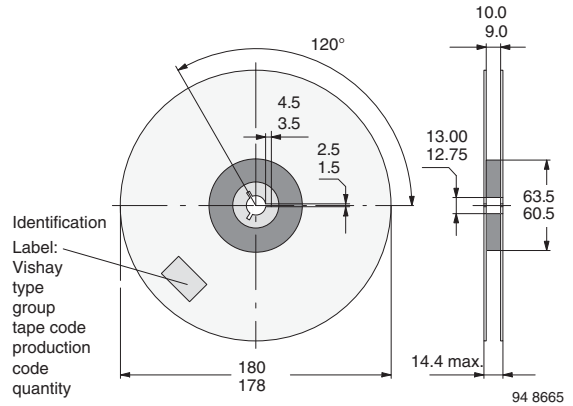

Figure 24. Reel Dimensions - GS08

**TAPING OF VLM.3..**

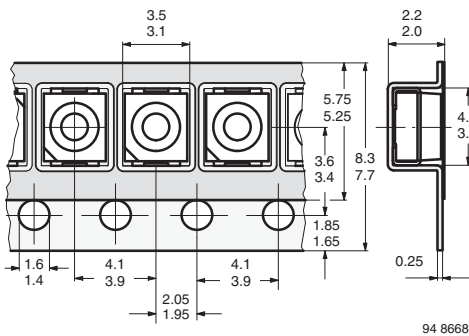

Figure 23. Tape Dimensions in mm for PLCC-2

**REEL PACKAGE DIMENSION IN MILLIMETERS FOR SMD LEDS, TAPE OPTION GS18 (= 8000 PCS.) PREFERRED**

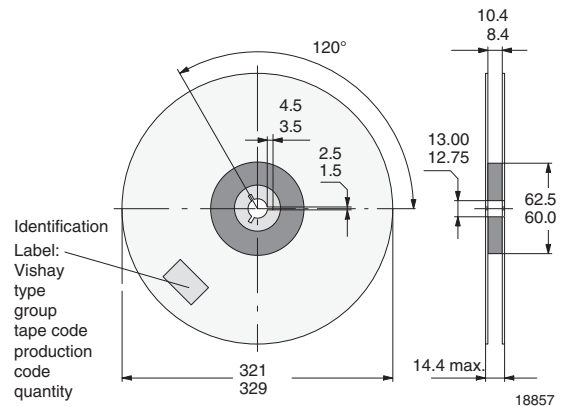

Figure 25. Reel Dimensions - GS18

**SOLDERING PROFILE**

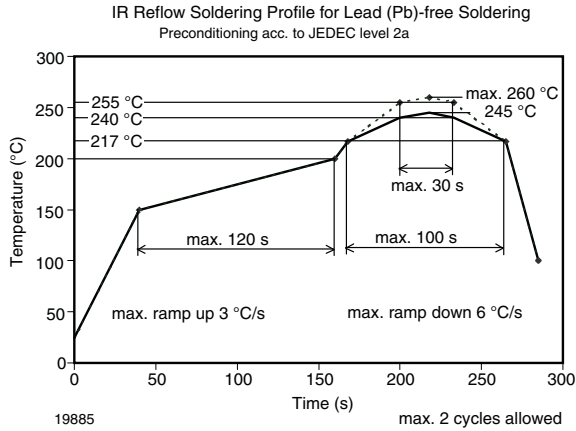

Figure 26. Vishay Lead (Pb)-free Reflow Soldering Profile (acc. to J-STD-020)

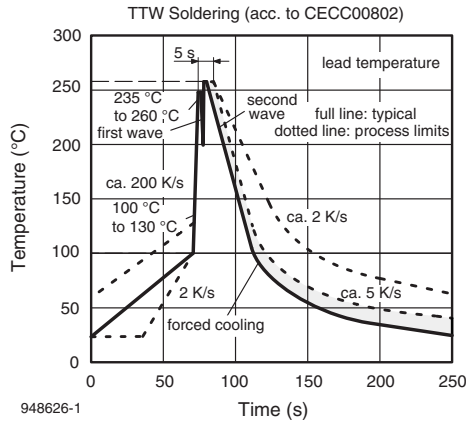
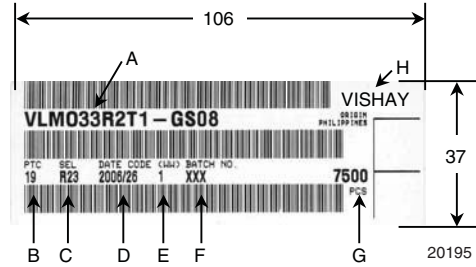

Figure 27. Double Wave Soldering of Opto Devices (all Packages)

**BAR CODE PRODUCT LABEL EXAMPLE:**



- A) Type of component
- B) Manufacturing plant
- C) SEL - selection code (bin):  
e.g.: R2 = code for luminous intensity group  
3 = code for color group
- D Date code year/week
- E) Day code (e.g. 1: Monday)
- F) Batch no.
- G) Total quantity
- H) Company code

**DRY PACKING**

The reel is packed in an anti-humidity bag to protect the devices from absorbing moisture during transportation and storage.

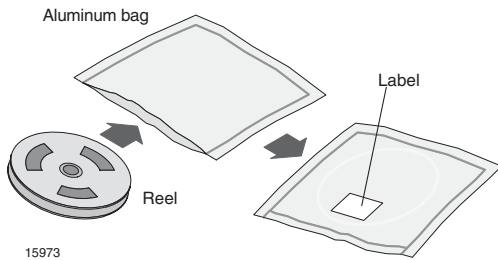
**FINAL PACKING**

The sealed reel is packed into a cardboard box. A secondary cardboard box is used for shipping purposes.

**RECOMMENDED METHOD OF STORAGE**

Dry box storage is recommended as soon as the aluminum bag has been opened to prevent moisture absorption. The following conditions should be observed, if dry boxes are not available:

- Storage temperature 10 °C to 30 °C
- Storage humidity ≤ 60 % RH max.

After more than 672 h under these conditions moisture content will be too high for reflow soldering.

In case of moisture absorption, the devices will recover to the former condition by drying under the following condition:

192 h at 40 °C + 5 °C/- 0 °C and < 5 % RH (dry air/nitrogen) or

96 h at 60 °C + 5 °C and < 5 % RH for all device containers or

24 h at 100 °C + 5 °C not suitable for reel or tubes.

An EIA JEDEC Standard JESD22-A112 Level 2a label is included on all dry bags.

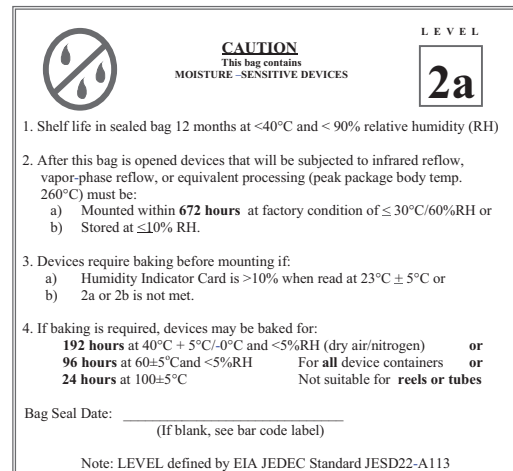

Example of JESD22-A112 Level 2a Label

**ESD PRECAUTION**

Proper storage and handling procedures should be followed to prevent ESD damage to the devices especially when they are removed from the antistatic shielding bag. Electro-static sensitive devices warning labels are on the packaging.

**VISHAY SEMICONDUCTORS STANDARD BAR CODE LABELS**

The Vishay Semiconductors standard bar-code labels are printed at final packing areas. The labels are on each packing unit and contain Vishay Semiconductors specific data.



## Disclaimer

ALL PRODUCT, PRODUCT SPECIFICATIONS AND DATA ARE SUBJECT TO CHANGE WITHOUT NOTICE TO IMPROVE RELIABILITY, FUNCTION OR DESIGN OR OTHERWISE.

Vishay Intertechnology, Inc., its affiliates, agents, and employees, and all persons acting on its or their behalf (collectively, "Vishay"), disclaim any and all liability for any errors, inaccuracies or incompleteness contained in any datasheet or in any other disclosure relating to any product.

Vishay makes no warranty, representation or guarantee regarding the suitability of the products for any particular purpose or the continuing production of any product. To the maximum extent permitted by applicable law, Vishay disclaims (i) any and all liability arising out of the application or use of any product, (ii) any and all liability, including without limitation special, consequential or incidental damages, and (iii) any and all implied warranties, including warranties of fitness for particular purpose, non-infringement and merchantability.

Statements regarding the suitability of products for certain types of applications are based on Vishay's knowledge of typical requirements that are often placed on Vishay products in generic applications. Such statements are not binding statements about the suitability of products for a particular application. It is the customer's responsibility to validate that a particular product with the properties described in the product specification is suitable for use in a particular application. Parameters provided in datasheets and/or specifications may vary in different applications and performance may vary over time. All operating parameters, including typical parameters, must be validated for each customer application by the customer's technical experts. Product specifications do not expand or otherwise modify Vishay's terms and conditions of purchase, including but not limited to the warranty expressed therein.

Except as expressly indicated in writing, Vishay products are not designed for use in medical, life-saving, or life-sustaining applications or for any other application in which the failure of the Vishay product could result in personal injury or death. Customers using or selling Vishay products not expressly indicated for use in such applications do so at their own risk and agree to fully indemnify and hold Vishay and its distributors harmless from and against any and all claims, liabilities, expenses and damages arising or resulting in connection with such use or sale, including attorneys fees, even if such claim alleges that Vishay or its distributor was negligent regarding the design or manufacture of the part. Please contact authorized Vishay personnel to obtain written terms and conditions regarding products designed for such applications.

No license, express or implied, by estoppel or otherwise, to any intellectual property rights is granted by this document or by any conduct of Vishay. Product names and markings noted herein may be trademarks of their respective owners.